

TECHNICAL DATA AWIFLOW

Subject to technical modifications (10.3)

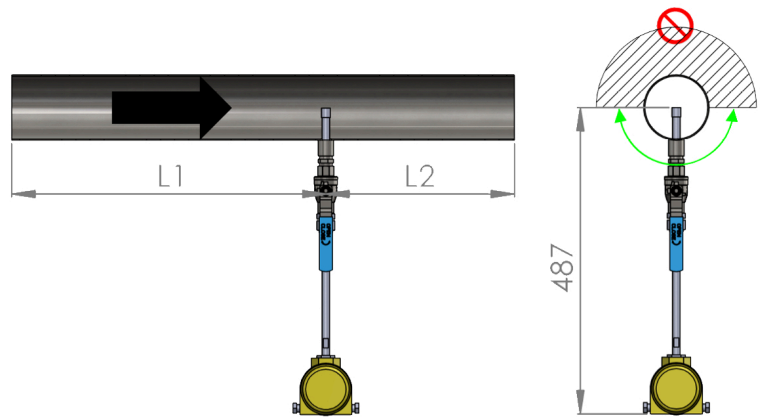

FLOW MEASUREMENT AWIFLOW

GENERAL INFORMATION

Areas of application	Mass flow measurement for dry or moist biogas, manure gas, landfill gas
Sensor length	305 mm
Flow velocity:	0,3...15 m/s (others on request)

OPERATING CONDITIONS

Ambient Temperature	-18...60°C
Medium temperature	+5...50 °C (optional -18...121 °C)
Medium pressure	max. 10 bar (optional 34 bar)
Protection type	IP67
Ex approval	Zone 1, ATEX / IECEx: II 2 G / Ex d IIC T6...T3

SENSOR

Installation	Compact unit for installation in existing pipeline (DN50...350) incl. cable glands, mounting fitting and compression fitting for process connection to internal thread G1/2"
Material	Stainless steel 316L (body), Hastelloy-C22 (thermocouple sensors)
Measured value deviation	± 2% (optional ± 1%) of the measured value plus 0.5% of the final value
Recommended inlet/outlet section	depending on pipe run 10...20 x pipe Ø (inlet) / 3...10 x pipe Ø (outlet)

STAND-ALONE

COMBINATION WITH GAS ANALYSIS

Calibration	with real gas (methane in carbon dioxide)	With real gas (methane in carbon dioxide) plus compensation via current gas composition of the measuring gas
Signal outputs	+ 4...20 mA for current flow + 4...20 mA for temperature or summation (selectable) + pulse output for summation	freely selectable: + Ethernet + Modbus RS485 / RS 232 + Profibus + 4...20 mA + more on request
Voltage supply	18...36 V DC (6 W max)	via gas analysis system
Display	optional: two-line, 16 characters each, LCD + flow rate + temperature or total flow	7" TFT touch panel with internal data memory + tabular or graphical display + standard flow ¹ Standard flow meter ¹ + temperature ¹ + absolute humidity ¹ + output (in kW) ^{1,2} + current calorific value ^{1,2} + energy meters ^{1,2} + average Calorific value ^{1,2} + relative humidity ^{1,2}

¹ Performance Package Energy

² Performance Package Compensation